

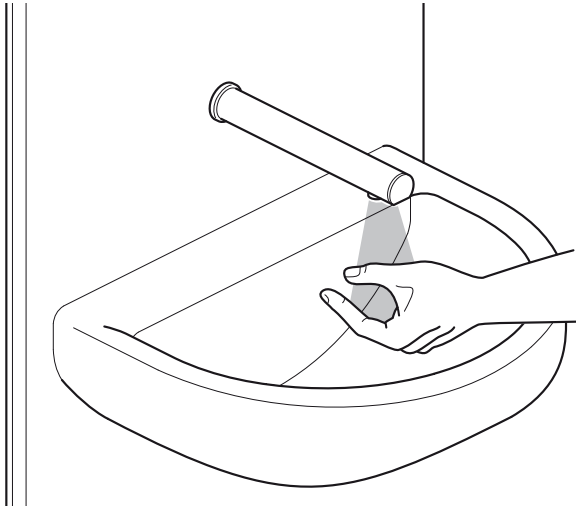

# Rada Outlook 150, 190 & 225mm Sensor Spout



T-logic™ Digital Intelligence



For wall panel installation

## PRODUCT MANUAL

### IMPORTANT

**Installer:** This Manual is the property of the customer and must be retained with the product for maintenance and operational purposes.

## DESCRIPTION

A wall panel mounted basin spout with an integrated non touch on/off sensor. Included with adapter fittings for 15mm pushfit and 6m signal cable. For connection to the Rada Outlook Sensor Box.

## SAFETY : WARNINGS

The primary function of this product is to aid the delivery of water consistently at a desired temperature. This requires that:

1. It is installed, commissioned, operated and maintained in accordance with the recommendations given in this manual.
2. Periodic attention is given, as necessary, to maintain the product in good functional order.
3. If this equipment is used in a manner not specified by Kohler Mira Ltd, the protection provided by the equipment may become impaired.
4. The electrical installation **must** comply with BS 7671 (commonly referred to as the IEE Wiring Regulations) and all relevant building regulations, or any particular regulation or practice specified by the local electricity supply company.

## PACK CONTENTS

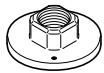

1 x Securing Nut



1 x Washer



1 x Elbow

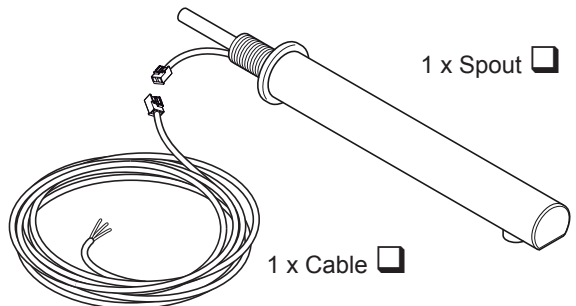

1 x Spout

1 x Cable

# SPECIFICATION

## Standards and Approvals

The **Rada Outlook 150, 190 and 225 mm Sensor Spouts** comply with all relevant directives for CE marking.

Power Input                      5V DC supply provided by the Rada Outlook Sensor Box.

# INSTALLATION

## General

**Installation must be carried out in accordance with these instructions, and must be conducted by designated, qualified and competent personnel.**

The plumbing installation **must** comply with the requirements of the UK Water regulations/Bye-Laws (Scotland), or any particular regulations and practices specified by the local water company or water undertakers.

**Warning! Do Not** connect mains voltage directly to the spout.

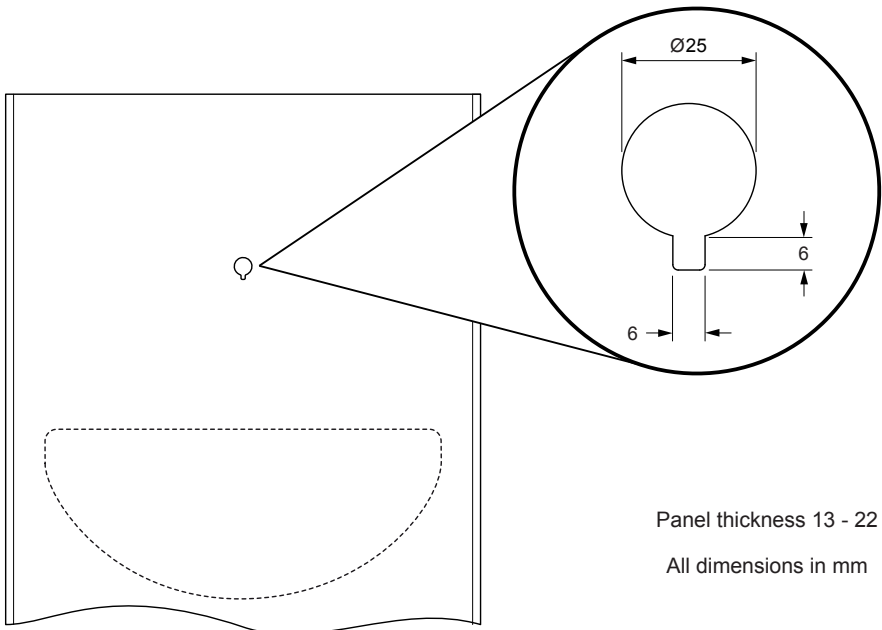

Panel thickness 13 - 22

All dimensions in mm

Panel Dimension Diagram

1

(see "Panel Dimension Diagram"  
for details)

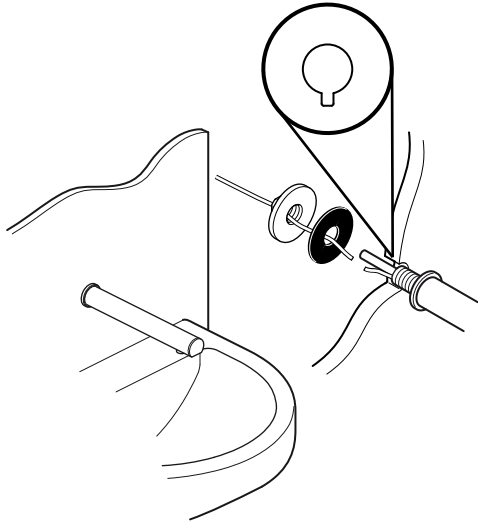

2

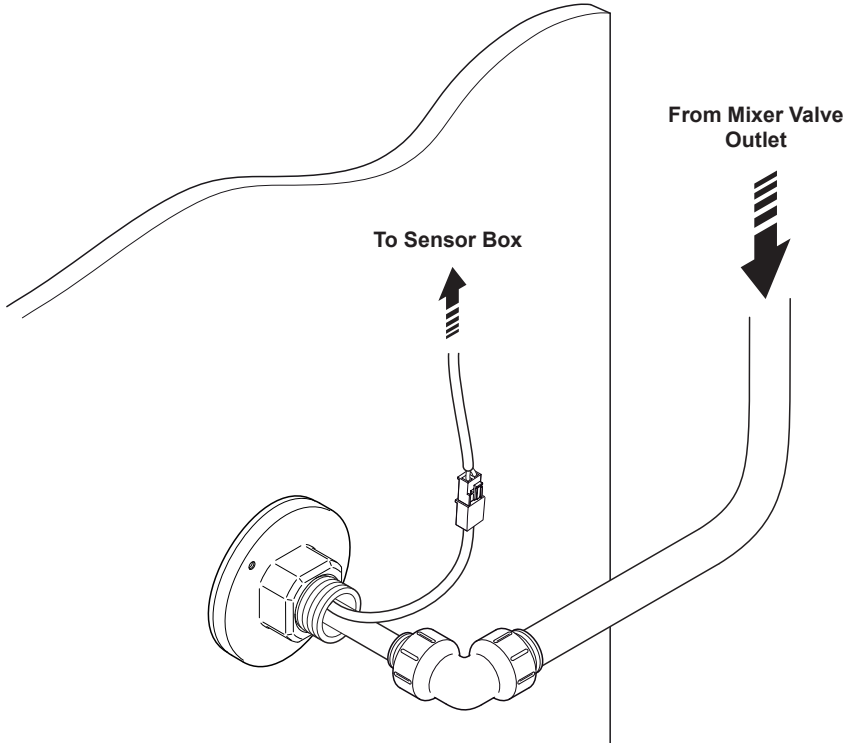



# 1621.102 / 1621.107

4

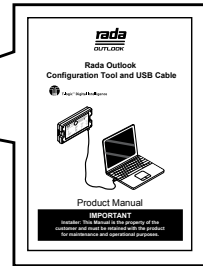
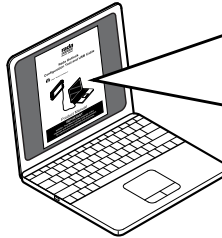

5

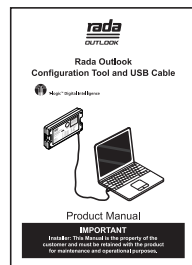
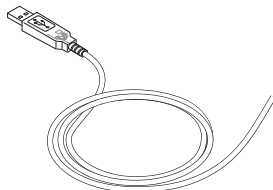
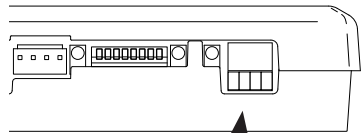
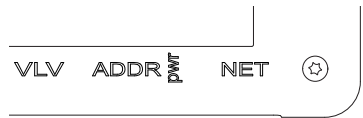
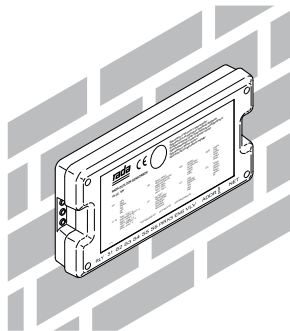

6

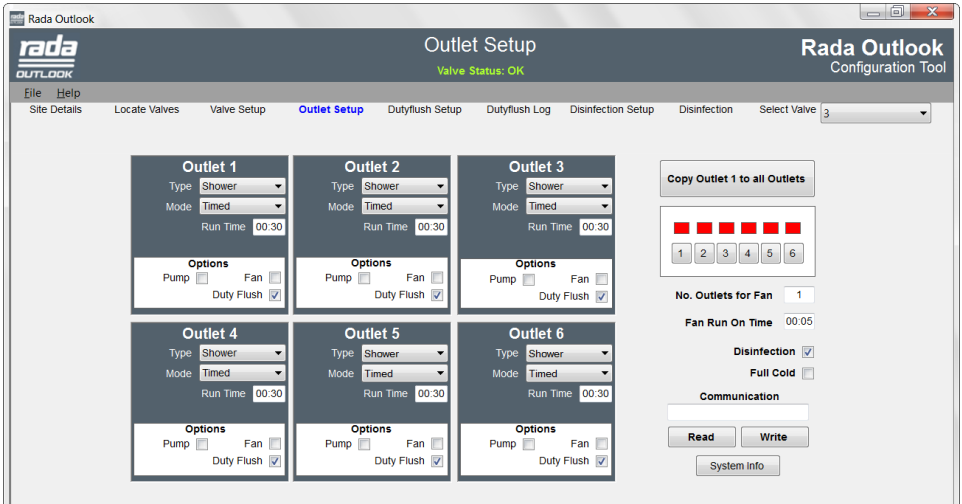

**Change the outlet "Type" to "Basin" and select the appropriate "Mode" and "Run Time" settings. Press "Write" to set the changes.**

7

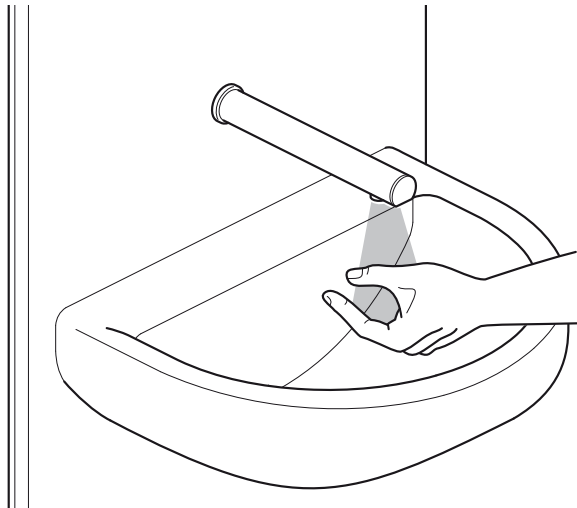

**Test the spout is working correctly.**

# CLEANING

The Rada Outlook Sensors may be disabled temporarily for cleaning and maintenance purposes. This is possible with the use of a Keyswitch or other similar device (not supplied) connected to the Sensor Box. (The Rada Keyswitch is available as an accessory suitable for this purpose, see “Accessories”).

Chrome Plated or plastic fittings should only be cleaned using a mild washing up detergent or soap solution and wiped dry with a soft cloth.

# FAULT DIAGNOSIS

Maintenance **must** be conducted by designated, qualified and competent personnel.

**Note!** The following table is not an extensive list of faults, if you find a fault that is not listed below, please contact us for assistance.

Most faults can be rectified by checking the following:

**Make sure the water supply has not been interrupted. All isolating valves should be fully open.**

Symptom	Probable Cause	Remedy
1. Sensor not working. Sensor works once, then not at all.	<b>A.</b> Faulty connection.  <b>B.</b> Faulty Sensor.	<b>A.</b> Check sensor wiring. Check wires are making good contact with the Sensor Box. If wires have been extended, check connectors between Sensor and Sensor Box.  <b>B.</b> Replace sensor.
2. New or replacement Sensor not working within the first few seconds of being connected, Sensor works correctly afterwards.	<b>A.</b> Sensor is being calibrated.  <b>B.</b> Sensor connected to a live (powered) Sensor Box.	<b>A.</b> Allow 5-10 seconds for the system to calibrate the Sensor before operation.  <b>B.</b> Isolate power to the Sensor Box before connecting the Sensor.



# ACCESSORIES



1621.112 Rada Outlook IR  
Hand Sensor (6m)



1621.228 Rada Outlook IR  
Hand Sensor (10m)

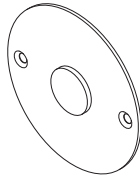

1621.085 Rada Outlook  
Piezo Hand Sensor

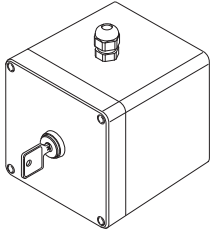

2.1495.080 Rada  
Isolating Keyswitch

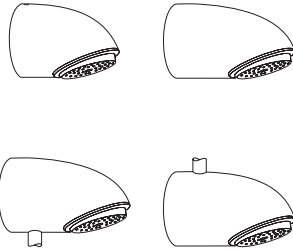

## Outlet Fittings:

Rada has a comprehensive range of spouts and shower fittings, available separately.

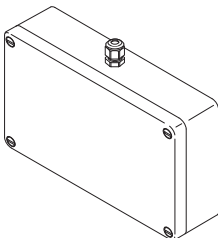

2.1495.044 Rada Relay Box



1621.116 Rada Outlook RS485 Socket

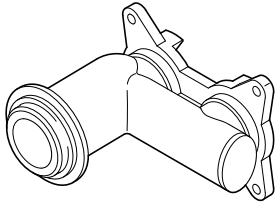

1621.115 Outlet By-Pass Adapter

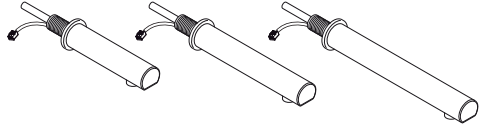

1621.136 150 mm Spout Assembly

1621.132 190 mm Spout Assembly

1621.137 225 mm Spout Assembly

## SPARE PARTS

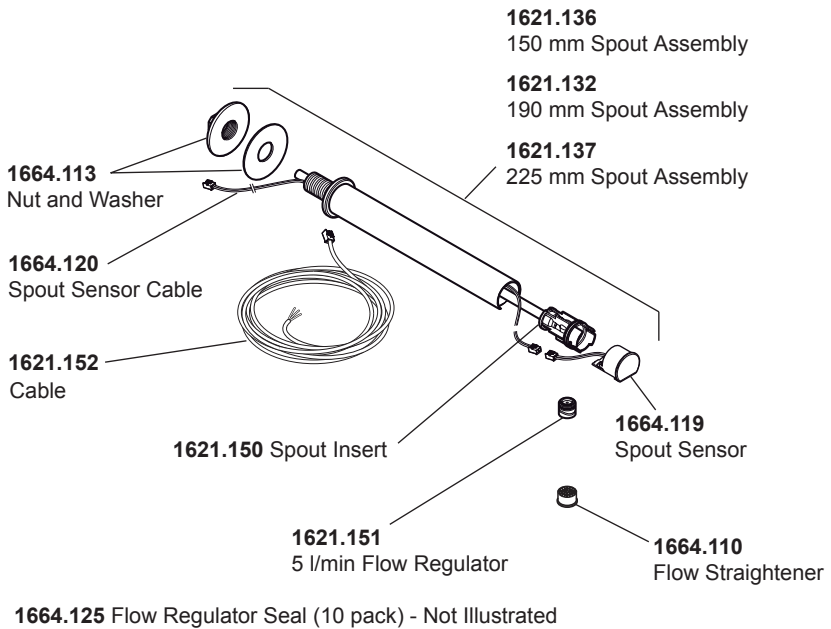

# DISPOSAL & RECYCLING

## End of Product Life

When the appliance has reached the end of its serviceable life, it should be disposed of in a safe manner and in accordance with the current local authority recycling or waste disposal policy.



# GUARANTEE

## Guarantee

### Rada Outlook IR Sensor and Piezo Sensor

We guarantee these products against any defect in materials or workmanship for the period of **one year** from the date of purchase. For terms and conditions refer to the back cover of this guide.

# CUSTOMER SERVICE

## Guarantee

Your product has the benefit of our manufacture's guarantee which starts from date of purchase. Within the guarantee period we will resolve defects in materials or workmanship, free of charge, by repairing or replacing parts or product as we may choose.

**This guarantee is in addition to your statutory rights and is subject to the following conditions:**

- The product must be installed and maintained in accordance with the instructions given in this user guide.
- Servicing must only be undertaken by us or our appointed representative. **Note!** If a service visit is required the product must be fully installed and connected to services.
- Repair under this guarantee does not extend the original expiry date. The guarantee on any replacement parts or product ends at the original expiry date.
- For shower fittings or consumable items we reserve the right to supply replacement parts only.

**The guarantee does not cover:**

- Call out charges for non product faults (such as damage or performance issues arising from incorrect installation, improper use, inappropriate cleaning, lack of maintenance, build up of limescale, frost damage, chemical attack, corrosion, system debris or blocked filters) or where no fault has been found with the product.
- Water or electrical supply, waste and isolation issues.
- Compensation for loss of use of the product or consequential or indirect loss of any kind.
- Damage or defects caused if the product is repaired or modified by persons not authorised by us or our appointed representative.
- Routine maintenance or replacement parts to comply with the requirements of the TMV2 or TMV3 healthcare schemes
- Accidental or wilful damage.
- Products purchased ex-showroom display.

## What to do if something goes wrong

If your product does not work correctly refer to this manual for fault diagnosis and check that it is installed and commissioned in accordance with our instructions. If this does not resolve the issue, contact us for help and advice.



## Technical Helpdesk Service

Contact our Customer Services Team for product advice, to purchase spare parts or accessories or to set up service visit. You can contact us via phone or e-mail - contact details below. Please provide your model name, power rating (if applicable) and date of purchase.



## Rada Website ([www.radacontrols.com](http://www.radacontrols.com))

From our website you can view our full product catalogue or download a brochure.



## Spares and Accessories

We hold the largest stocks of genuine Rada spares and accessories.



## Service/Repairs

No one knows our products better than our nationwide team of Service Technicians. We can carry out service or repair work to your product both during and after the guarantee period. You have the assurance of a fully trained Technician, genuine Rada spare parts and a 12 month guarantee on any chargeable work done.

## Service Contracts

Regular servicing ensures your product continues to operate at the peak of performance. We offer annual or bi-annual servicing carried out by our fully trained technicians subject to site survey

## To Contact Us - UK Customer Service & Specification Enquiries



**0844 571 1777**

Calls cost 7p per minute plus your phone company's access charge



**Fax: 0844 472 3076**



Email – Visit

[rada\\_technical@mirashowers.com](mailto:rada_technical@mirashowers.com)



By Post: Rada Controls, Cromwell Road, Cheltenham, Gloucestershire GL52 5EP

## To Contact Us: Eire Only



**01 531 9337**



E-mail:

[CustomerServiceEire@mirashowers.com](mailto:CustomerServiceEire@mirashowers.com)

*Rada is a registered trade mark of Kohler Mira Limited.*

*The company reserves the right to alter product specifications without notice.*

